



# 6730i IP Phone

## Installation Guide

41-001277-00

Rev 00





# Software License Agreement

Aastra Telecom Inc., hereinafter known as "Seller", grants to Customer a personal, worldwide, non-transferable, non-sublicenseable and non-exclusive, restricted use license to use Software in object form solely with the Equipment for which the Software was intended. This Product may integrate programs, licensed to Aastra by third party Suppliers, for distribution under the terms of this agreement. These programs are confidential and proprietary, and are protected as such by copyright law as unpublished works and by international treaties to the fullest extent under the applicable law of the jurisdiction of the Customer. In addition, these confidential and proprietary programs are works conforming to the requirements of Section 401 of title 17 of the United States Code. Customer shall not disclose to any third party such confidential and proprietary programs and information and shall not export licensed Software to any country except in accordance with United States Export laws and restrictions.

Customer agrees to not reverse engineer, decompile, disassemble or display Software furnished in object code form. Customer shall not modify, copy, reproduce, distribute, transcribe, translate or reduce to electronic medium or machine readable form or language, derive source code without the express written consent of the Seller and its Suppliers, or disseminate or otherwise disclose the Software to third parties. All Software furnished hereunder (whether or not part of firmware), including all copies thereof, are and shall remain the property of Seller and its Suppliers and are subject to the terms and conditions of this agreement. All rights reserved.

Customer's use of this software shall be deemed to reflect Customer's agreement to abide by the terms and conditions contained herein. Removal or modification of trademarks, copyright notices, logos, etc., or the use of Software on any Equipment other than that for which it is intended, or any other material breach of this Agreement, shall automatically terminate this license. If this Agreement is terminated for breach, Customer shall immediately discontinue use and destroy or return to Seller all licensed software and other confidential or proprietary information of Seller. In no event shall Seller or its suppliers or licensors be liable for any damages whatsoever (including without limitation, damages for loss of business profits, business interruption, loss of business information, other pecuniary loss, or consequential damages) arising out of the use of or inability to use the software, even if Seller has been advised of the possibility of such damages.



# Table of Contents

Software License Agreement.....	iii
Introduction .....	1
Phone Features .....	1
Requirements .....	1
About This Guide .....	2
Phone Parts .....	3
Key Panel.....	4
Key Description.....	5
Installation and Setup.....	8
Network Connection .....	8
Power Adapter.....	8
Connecting a Handset .....	9
Desk or Wall Installation.....	9
Inserting the Key Card.....	13
Customizing your phone.....	14
Accessing Your Options via the Phone UI.....	15
Accessing Your Options via the Aastra Web UI.....	15
IP Phone Features.....	17
Call Forward .....	17
Preferences .....	18
Phone Status .....	20
User Password .....	20
Administrator Menu .....	20
Restart Phone.....	20
Phone Lock.....	20
Other Phone Features .....	21
Adjusting the Volume .....	21
Status Lights (LEDs).....	21
Call Timer.....	21
Programmable keys.....	22
Creating a Speedial Key .....	23
Line/Call Appearance Keys.....	26
Troubleshooting Solutions .....	27
Limited Warranty.....	29



## Introduction

Congratulations on your purchase of the Model 6730i IP Phone IP Phone! The 6730i IP Phone communicates over an IP Network, allowing you to receive and place calls in the same manner as a regular business telephone. The 6730i is capable of supporting the SIP protocol.

### Phone Features

- 3-line LCD screen
- 8 programmable top keys
- Press-and-hold speeddial key configuration feature
- Supports up to 6 call lines with LEDs
- Full-duplex speakerphone for handsfree calls
- AC power adapter (included)
- Enhanced busy lamp fields\*
- Set paging\*

\*Availability of feature dependant on your phone system or service provider.

### Requirements

- SIP-based IP PBX system or network installed and running with a SIP account created for the 6730i IP Phone phone.
- Access to a Trivial File Transfer Protocol (TFTP), File Transfer Protocol (FTP), Hypertext Transfer Protocol (HTTP) server, or Hyper Text Transfer Protocol over Secure Sockets Layer (SSL) (HTTPS).
- Ethernet/Fast Ethernet LAN (10/100 BaseT)
- Category 5/5e straight through cabling
- Power source

## About This Guide

This manual describes how to physically set up your new 6730i. Not all features listed are available by default and some may depend on your phone system or service provider. Contact your system administrator if you have any questions on what features and services are available to you on your system. This guide complements the *SIP IP Phone Administrator Guide* and the *Aastra Model 6730i IP Phone User Guide*.

**SIP IP Phone Administrator Guide** – is designed for network administrators, system administrators, developers and partners who need information on installing this product on an IP network.

**Aastra Model 6730i IP Phone User Guide** – explains the most commonly used IP telephone features for an end user.

These guides along with release notes, system updates, etc. can be downloaded from our Web site at [www.aastratelecom.com](http://www.aastratelecom.com)



## Phone Parts

When you unpack your phone, you should ensure that you have all of the following items. If any part is missing, contact the supplier of your phone.

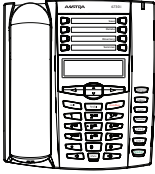

Telephone



Handset



Handset  
Cord



Key Card

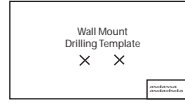

Wall Mount  
Drilling Template

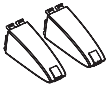

Telephone  
Base Desk  
Legs



Power  
Adapter



Ethernet  
Cable



6730i Installation  
Guide CD







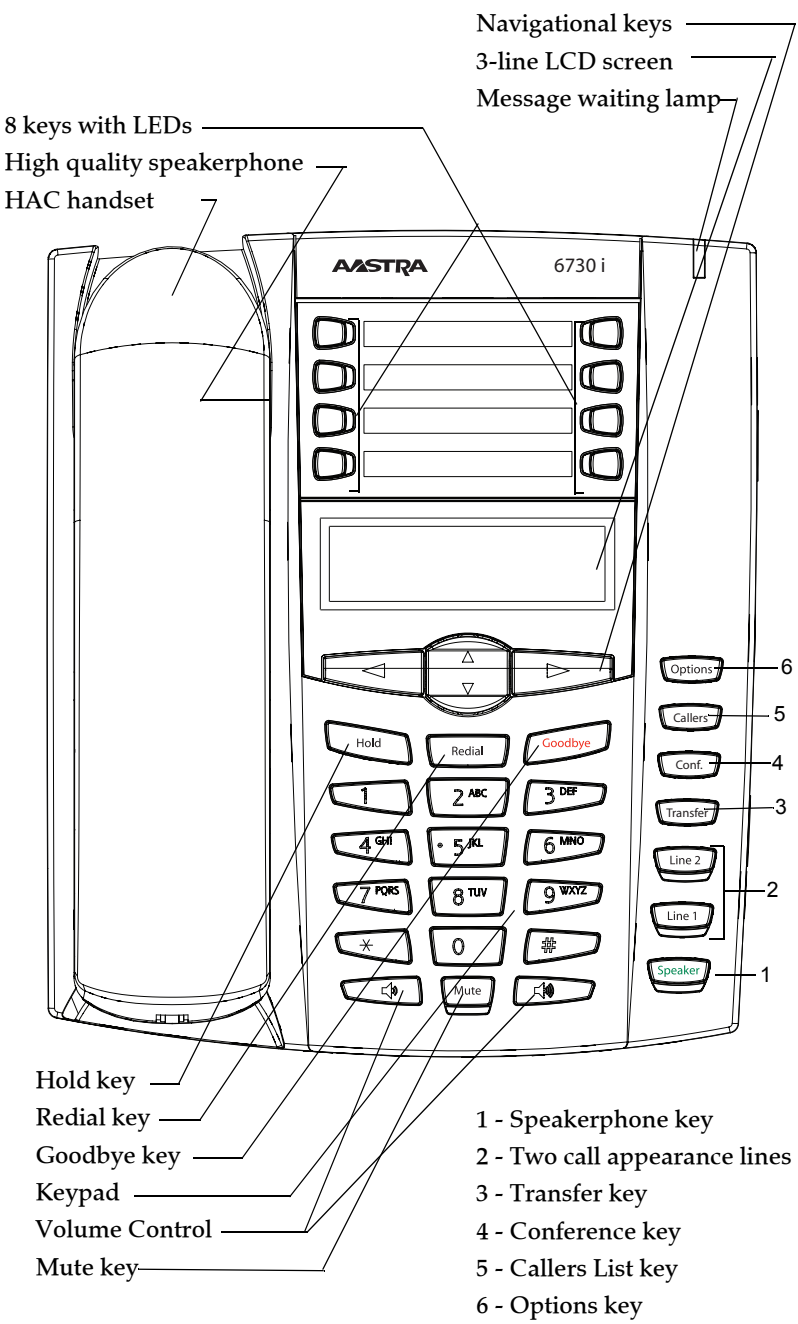



Screws and  
Anchors for  
Wall Mounting





## Key Panel



## Key Description

The following table describes the keys on the 6730i. Refer to the *Aastra Model 6730i IP Phone User Guide* for more information about these keys.

Keys	Key Description
	<b>Hold key</b> - Places an active call on hold. To retrieve a held call, press the call appearance button beside the light that is flashing.
	<b>Redial key</b> - Redials up to 100 previously dialed numbers. Pressing the Redial key twice redials the last dialed number.
	<b>Goodbye key</b> - Ends an active call. The Goodbye key also exits an open list, such as the Options List, without saving changes.
	<b>Volume control key</b> - Adjusts the volume for the handset, ringer, and handsfree speaker. See " <a href="#">Adjusting the Volume</a> " on <a href="#">page 21</a> for more information.
	<b>Navigation keys</b> - Pressing the UP and DOWN arrow keys lets you view different status and text messages on the LCD display (if there is more than 1 line of status/text messages). These buttons also let you scroll through menu selections, such as the Options List.  Pressing the LEFT and RIGHT arrow keys lets you view the different line/call appearances. While in the Options List, these keys allow you to exit or enter the current option. When you are editing entries on the display, pressing the LEFT arrow key erases the character on the left; pressing the RIGHT arrow key sets the option.
	<b>Speaker key</b> - Transfers the active call to the speaker, allowing handsfree use of the phone.
	<b>Options key</b> - Accesses services and options to customize your phone. Your System Administrator may have already customized some of your settings. Check with your System Administrator before changing the administrator-only options.
	<b>Callers List key</b> - Accesses the last 200 calls received.

Keys	Key Description
 A rectangular button with rounded corners and a black border, containing the text "Conf." in a sans-serif font.	<b>Conference key</b> - Begins a conference call with the active call.
 A rectangular button with rounded corners and a black border, containing the text "Transfer" in a sans-serif font.	<b>Transfer key</b> - Transfers the active call to another number.
  Two rectangular buttons with rounded corners and black borders. The top one contains "Line 2" and the bottom one contains "Line 1", both in a sans-serif font.	<b>Line/Call Appearance keys</b> - Connect you to a line or call. The Aastra 6730i IP Phone IP phone supports 2 line keys, each with LED indicator lights.

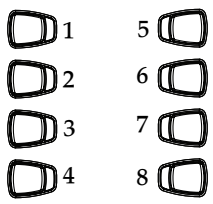
Keys	Key Description
	<p><b>Programmable keys - 8 Top Keys - all 8 keys are programmable.</b></p> <p><b>Note:</b> Keys 5 and 6 are designated as the SAVE and DELETE keys, respectively. These keys must be made configurable by the System Administrator before they can be changed.</p> <p>The following are the default functions for the programmable keys on the 6730i IP Phone IP phone:</p> <p><b>1 - None</b>  <b>2 - None</b>  <b>3 - None</b>  <b>4 - None</b>  <b>5 - SAVE</b> (preconfigured)      Allows you to save numbers and/or names to the Directory. Using this key, you enter the number, name, and line (or speedial key) to record in the Directory List.</p> <p><b>6 - DELETE</b> (preconfigured)      Allows you to delete entries from the Directory List and Callers List. (Must enter the Directory or Callers list and select an entry, then press twice to delete entry).</p> <p><b>7 - DIRECTORY</b> (preconfigured)      Displays up to 200 names and phone numbers (stored in alphabetical order)</p> <p><b>8 - SERVICES</b> (preconfigured)      Accesses enhanced features and services through the Services menu.</p> <p><b>Note:</b> For more information about configuring the SAVE and DELETE keys, contact your System Administrator.</p> <p><b>Note:</b> For more information about programming keys to perform specific functions, see the <i>Aastra 6730i IP Phone IP Phone User Guide</i>.</p>

## Installation and Setup

If your System Administrator has already setup your phone, please refer to the *Aastra 6730i IP Phone User Guide* for call handling information or contact your System Administrator.

### Network Connection

The port marked with **LAN** is used to connect the phone to the network.

### Power Adapter

Use the power adapter (provided) with your phone and plug your phone into a power source.

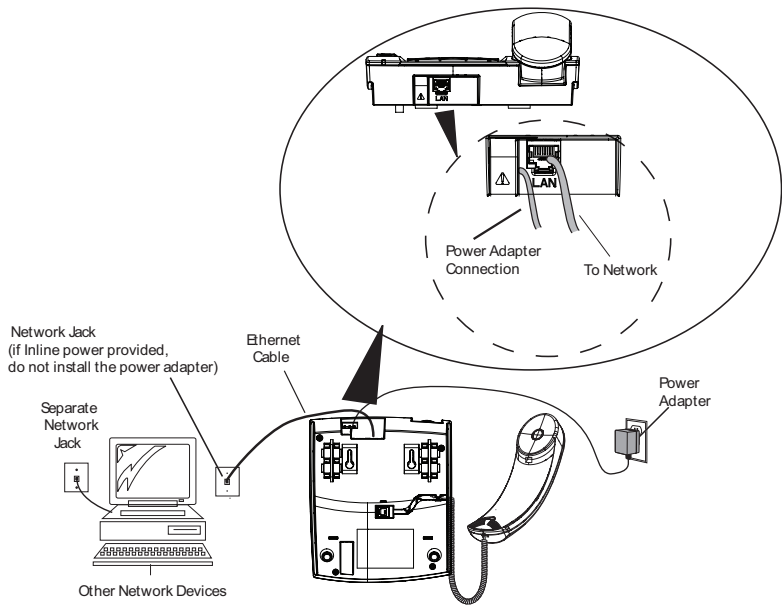

## Connecting a Handset

Turn the phone over and locate the handset jack marked . Insert one end of handset cord into the jack until it clicks into place. Then route the handset cord through the groove as shown in the illustration below. Attach the handset to the other end of the handset cord.

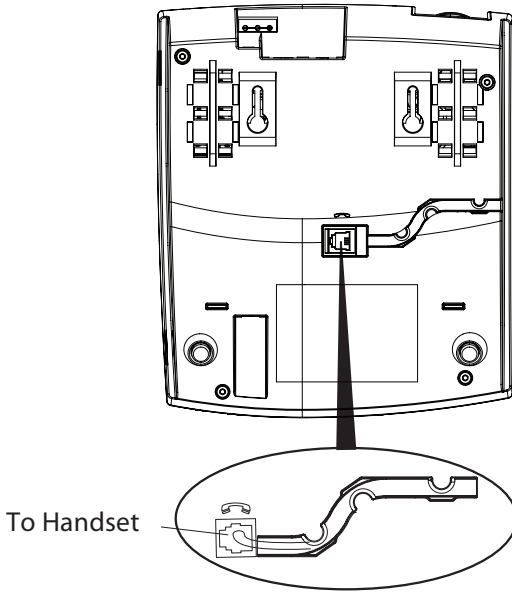

## Desk or Wall Installation

### *Install on the Desk*

The desk installation for the 6730i IP Phone IP phone consists of two legs that attach to the back of the phone near the top corners. A total of four different viewing angles allows users to personalize their phone viewing preference.

1. Attach each leg by inserting the tabs on the leg into the slots on the bottom of the phone. There are three pair of leg slots on each corner of the phone; each leg uses two pairs (1&2, or 2&3) giving two leg positions designating different viewing angles. Furthermore, the legs can be reversed which offer two additional viewing angles.
2. For a higher viewing angle, use the second and third slots from the top.
3. For a lower viewing angle, use the first and second slots from the top.

4. Push the stand towards the phone until it snaps into place.

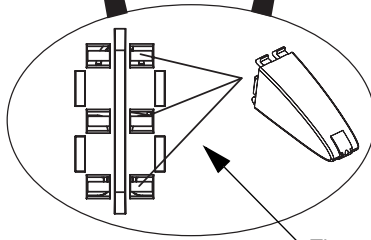
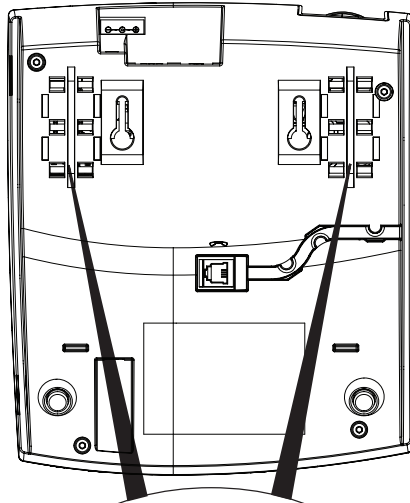

Three leg slot locations for customizing the height of the desk phone.

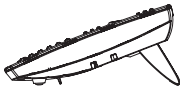

20.7 deg.  
Incline Angle



23.3 deg.  
Incline Angle



26.6 deg.  
Incline Angle

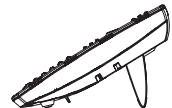

30.9 deg.  
Incline Angle

Four Different Viewing Angles

## ***Install on the Wall***

The 6730i IP Phone IP phone has two pre-drilled wall mounting holes on the back of the phone.

1. Using the provided wall mount drilling template, locate and mark the position for the mounting screws on the wall. Depending on the wall type, you may need to use wall anchors. Both the screws and wall anchors are included with your phone.
2. Place the wall mount holes on the phone over the screw heads on the



wall and pull down to lock the phone in.

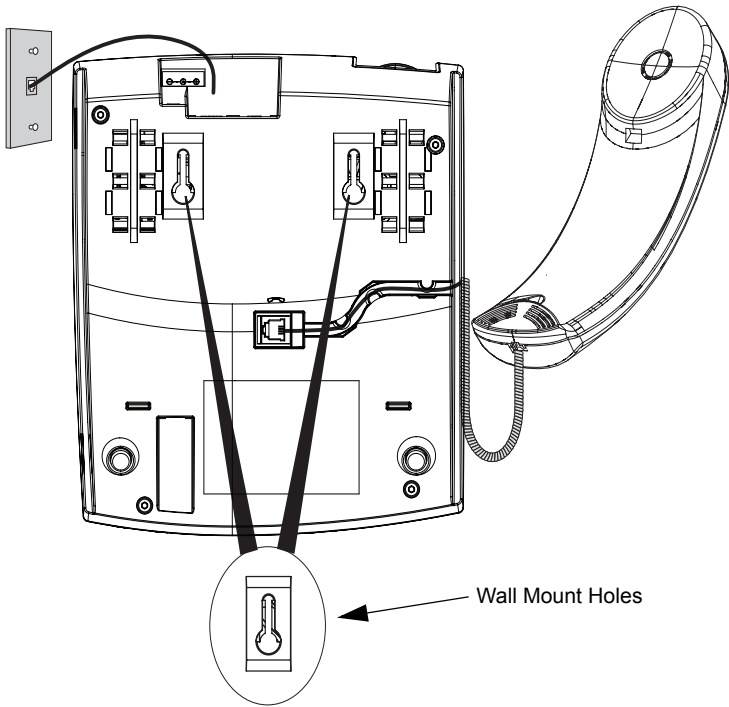

3. In the handset cradle, there is a small clip that sits flush with the cradle surface. Using a small flathead screwdriver, pull the clip up and remove it from the phone.
4. With the arms on the clip facing you and the flat side of the clip towards the phone, turn the clip 180 degrees and reinsert it back into the clip cavity in the phone's cradle.

5. Push the clip in until it snaps into the slot flush with the surface and only the legs on the clip are sticking up.

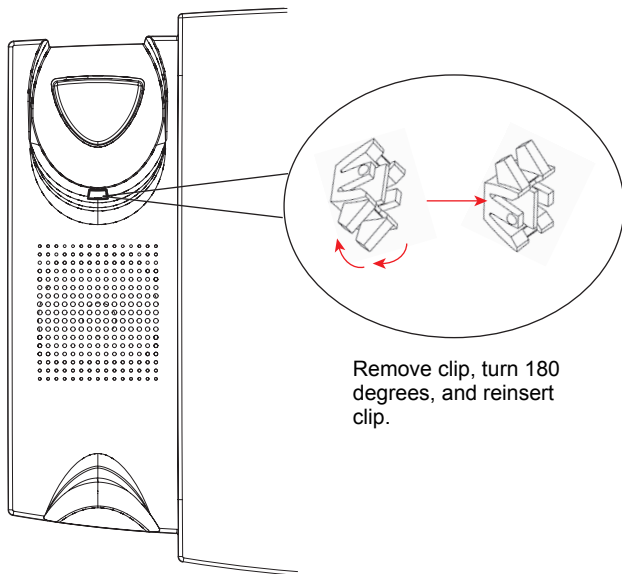

6. Place the handset into the phone's cradle, inserting the legs on the clip into the square hole on the handset. This allows the handset to rest in the cradle in a vertical position without slipping off when the phone is installed on the wall.

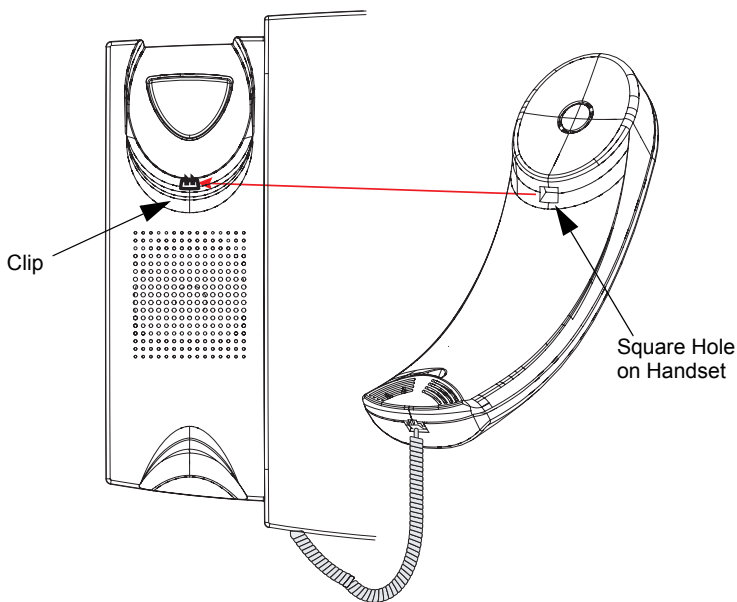

## Inserting the Key Card

This card contains the label identification spaces for 8 programmable keys.

1. Remove the logo plate from the top front panel of the telephone by gently pressing down and sliding upward.
2. Slide the card into the programmable key card slot on the top front panel of the telephone using the display slots for alignment. Ensure the tabs are sticking out for future removal of the card.
3. Gently slide the logo plate back in place, covering the paper tabs.

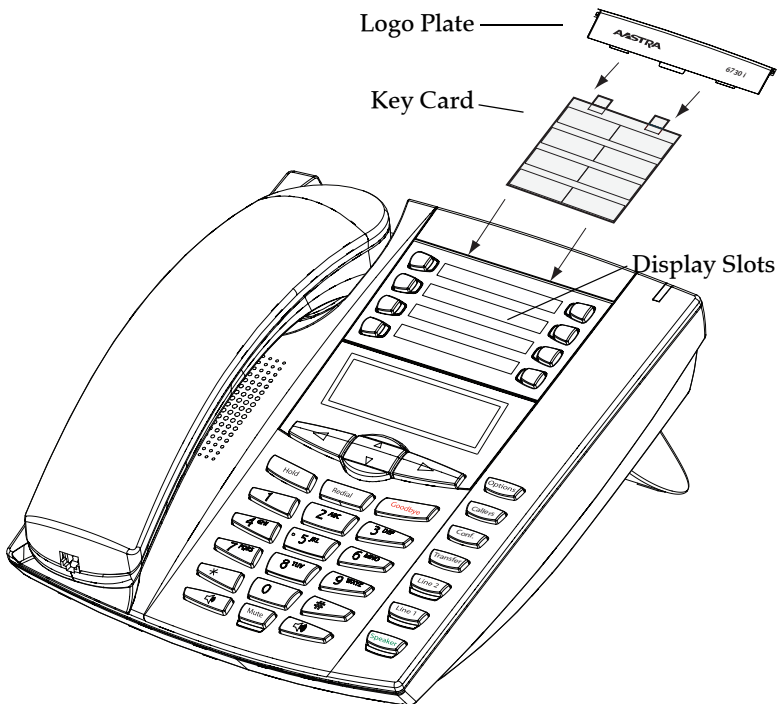



## Customizing your phone

There is a list of configuration options, accessed by pressing the  button on the phone. You can also access some of these options via the Aastra Web UI. The following table indicates the options and the method you can use to access these options on your phone.

Phone Option	Access from Phone UI	Access from Aastra Web UI
<b>Call Forward</b> Screenname All Off All On <b>Note:</b> The menus that display for Call Forward are dependant onthe Call Forward Mode set on the phone. Default is "Account" mode. See your Aastra 6730i User Guide for more information.	✓ ✓✓ ✓	✓ ✓✓ ✓
<b>Preferences</b> Tones Ring Tone Tone Set Contrast Level Speeddial Edit Live Dialpad Time Zone Time and Date Time Zone Daylight Savings Time Format Date Format Time Server Time Server 1 Time Server 2 Time Server 3 Set Time Set Date Language	✓ ✓✓ ✓✓ ✓✓ ✓✓ ✓✓ ✓✓ ✓✓ ✓✓ ✓✓ ✓✓ ✓ ✓ ✓ ✓✓ ✓✓ ✓	✓ ✓✓ ✓ ✓ ✓ ✓ ✓ ✓ ✓ ✓ ✓ ✓ ✓ ✓ ✓ ✓ ✓ ✓
<b>Phone Status</b> IP&MAC Addresses LAN Port PC Port Firmware Info	✓ ✓ ✓ ✓	✓ ✓ ✓ ✓
<b>User Password</b>	✓	✓
<b>Administrator Menu</b>	Administrator option only. Password protected.	
<b>Restart Phone</b>	✓	✓
<b>Phone Lock</b>	✓	✓

## Accessing Your Options via the Phone UI

1. Press the Options key  on the phone to enter the options list.
2. To go to an Option, use  $\Delta$  and  $\nabla$  to scroll through the list, or press the number corresponding to the Option.
3. Press the Show softkey, the  $\triangleright$  button, or press the digit number of the corresponding option to select an option.
4. Use the softkeys to change a selected option.
5. Press the Done softkey at any time to exit the option and save the change.
6. Press the Cancel softkey, the  $\triangleleft$  button, or the Goodbye key  at any time to exit without saving changes.

## Accessing Your Options via the Aastra Web UI

You can use the following procedure to access the phone options using the Aastra Web UI.



### Aastra Web UI

1. Open your web browser, enter the phone's IP address or host name into the address field and press **<Enter>**.  
The following logon screen displays.

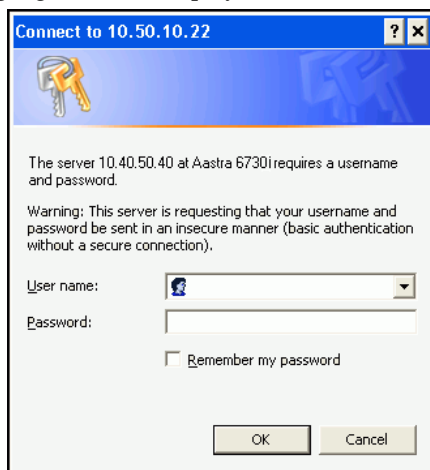

2. At the prompt, enter your username and password and click .

The Network Status window displays for the IP phone you are accessing.

**Note:** For a user, the default user name is “**user**” and the password field is left blank.

The screenshot shows the Aastra Web UI interface. At the top left is the Aastra logo, and at the top right is the model number '6730i' and a 'Log Off' link. A sidebar menu on the left contains the following items: Status, System Information, Operation, User Password, Phone Lock, Programmable Keys, Directory, Reset, Basic Settings, Preferences, and Account Configuration. The main content area is titled 'Network Status' and contains several sections:

- Network Status:** A table with columns 'Attribute', 'LAN Port', and 'PC Port'.
 

Attribute	LAN Port	PC Port
Link State	Up	Down
Negotiation	Auto	Auto
Speed	100Mbps	10Mbps
Duplex	Full	Half
- MAC Address:** 00-08-5D-16-11-34
- Hardware Information:** A table with columns 'Attribute' and 'Value'.
 

Attribute	Value
Platform	673i Revision 0
- Firmware Information:** A table with columns 'Attribute' and 'Value'.
 

Attribute	Value
Firmware Version	2.3.3.5
Firmware Release Code	SIP
Boot Version	1.1.0.1217
Date/Time	Feb 9 2008 02:07:51
- SIP Status:** A table with columns 'Line', 'SIP Account', 'Status', and 'Backup Registrar Used?'.
 

Line	SIP Account	Status	Backup Registrar Used?
1	9995551212@erroy.com	Registered	Yes
2	9995551212@erroy.com	Registered	Yes
3	9995551212@erroy.com	Registered	Yes

**3. You can logout of the Aastra Web UI at any time by clicking **Log Off**.**

The side menu options that display in the Network Status window are dependant on whether you log in as an Administrator or User. A longer list of options display in the side menu for an Administrator.

**Reference**

For more information about using the side menu options in the Aastra Web UI, see the *Aastra Model 6730i IP Phone IP Phone User Guide* or the *Aastra IP Phone Administrator Guide*.

# IP Phone Features

## Call Forward

Call Forward (CFWD) on the IP phone allows incoming calls to be forwarded to another destination. You can use Call Forwarding in two ways:

- Set call forwarding for all lines on the phone (global call forwarding).
- Set call forwarding on a per-account basis (only if your System Administrator has enabled multiple accounts on your phone)

**Note:** To use Call Forwarding on a per-account basis, contact your System Administrator.

You can set call forwarding for all the lines on your phone using the *Options->Call Forward* menu on the IP Phone UI, or at the path, *Basic Settings->Account Configuration* using the Aastra Web UI.

**Note:** The behavior of call forwarding on your phone is dependant on the **Call Forward Key Mode** parameter setting at the Web UI path, *Basic Settings->Preferences*. Valid values for this parameter can be **Account**, **Phone**, or **Custom**. However, if you only have one account configured on your phone, the call forwarding behavior defaults to the "**Phone**" setting.

Using the Phone UI, select *Options->Call Forward*, and use the  $\Delta$  and  $\nabla$  keys to select a Call Forward Mode (**All**, **Busy**, **NoAns**), and then specify a phone number for which to call forward your incoming calls to.

- **All** mode forwards all incoming calls to the number you specify.
- **Busy** mode forwards the calls to the specified number only if your phone is in the Busy state.
- **NoAns** mode forwards the calls to a specified number only if your phone does not answer the incoming calls after a specified number of rings.

If your System Administrator has enabled multiple accounts on your phone, you can configure Call Forwarding on a per-account basis.

### **Reference**

For more information about configuring Call Forwarding on your phone, see the *Aastra 6730i User Guide*.

## Preferences

The following paragraphs describe the features you can configure from the Preferences Menu.

### ***Ring Tone/Tone Set***

Use these options to set the preference of ring tone and call progress tones for your phone.

- Ring Tone  
Press the **CHANGE** softkey to select one of the five ring tones or silent. Use the volume bar to increase or decrease the ringer volume level.
- Tone Set  
Press the **CHANGE** softkey to select one of the seven predefined tone sets for the phone to play country specific call progress tones such as dial tone, ringing tone, busy tone, congestion tone, call waiting tone, and ringing cadence.

### ***Contrast Level***

Use this option to set the preference of contrast level for your phone.

- Contrast Level  
Use the **CHANGE** softkey to cycle through eight contrast settings, which brighten or darken the display.

### ***Speeddial Edit***

Use this option to create and edit keys that allow you to dial a number quickly by pressing the speeddial key. You can program a speeddial key to speeddial outside numbers, dial directly to another person's line or extension, or set up to quickly access features such as Caller ID (\*69), Voicemail.

### ***Reference***

For more information about creating speeddial keys on your phone, see the *Aastra 6730i User Guide*.

### ***Live Dialpad\****

This option turns the Live Dial Pad mode ON or OFF. With live dial pad ON, the phone automatically dials out and turns ON Handsfree mode as soon as a dial pad key or softkey is pressed. With live dial pad OFF, if you dial a number while the phone is on-hook, lifting the receiver or pressing  initiates a call to that number. Press the **CHANGE** softkey to turn ON or OFF the dial pad mode.

\*Availability of feature dependant on your phone system or service provider.



## ***Time and Date***

Use these options to set the local time on the phone. Depending upon the configuration, the time you specify here may be overwritten by the time specified by your System Administrator for your network. Contact your System Administrator for more information about network time.

- **Time Zone**  
Choose your current time zone. Select your country by scrolling through a list, or by entering the country code (i.e., CA, US), then pick from the time zone list for that country.
- **Daylight Savings**  
This option allows you to specify daylight savings.
- **Time Format**  
Select a time format for how time displays on your phone (12h or 24h clock).
- **Date Format**  
Choose from a list of formats for how the date displays on your phone.
- **Time Server**  
This option is password protected. Contact your System Administrator before making changes to this option.

If the Time Server option is enabled, the display shows the IP address where the phone is getting time and date information from on the Network. Whenever the phone starts up, it will automatically attempt to find the Time Server. If the Time Server is not found and unknown to the phone, the IP address will display as 0.0.0.0, and the time and date in the main screen displays the equivalent of "12:00 am Jan. 1st 2000". If the Time Server option is disabled, the display shows "Network Time Disabled". You can set the time and date manually on your phone.

- **Set Time**  
This option shows the Network time, if the Time Server option is enabled. It also allows you to set the time manually.  
**Note:** if you set the time manually, the phone does not try to synchronize the time with a timeserver until the next time it is restarted.
- **Set Date**  
This option shows the Network date, if the Timeserver option is enabled. It also allows you to enter the date manually.  
**Note:** if you set the date manually, the phone does not synchronize the date with a timeserver until the next time it is restarted.

## ***Language***

Select a language that you would like your phone to use for displaying prompts and menus.

**Note:** Supported languages may vary depending on your phone's configuration. Contact your System Administrator for a list of available languages.

## Phone Status

This option allows you to:

- View your network status including your phone's IP and MAC address
- View the LAN and PC port information
- View your firmware version
- View the Account Status on your phone (via the Aastra Web UI only)

## User Password

Use this option to change your user password. Valid values for entering a password are 0 to 4294967295 (integers only; symbols and alpha characters are not allowed). Default password is an empty string "" (field is blank).

## Administrator Menu

This is a System Administrator level-only option only, and is password protected. Contact your System Administrator for more information.



## Restart Phone

Use this option to restart your phone if required.

## Phone Lock

Use this option to lock the phone from unauthorized users. When the phone is locked, users are unable to dial from the phone unless it has been unlocked. To unlock the phone, press the  button and enter either the user or administrator password.





**Note:** While the phone is locked, only emergency number dialing is permitted. The default permissible emergency dial plan numbers are 911, 999, 112, and 110; this dial plan is configurable via the Aastra Web UI at the path, *Operation->Phone Lock*.

**Hint:** To quickly lock your phone, press the  button followed by the  key.

## Other Phone Features

### Adjusting the Volume

Pressing the volume button  adjusts the receiver, speaker, and ringer volume.

- To adjust the ringer volume, leave the handset in the cradle and press the volume button  while there is no active call. There are 10 settings for the ringer including Off — the display will temporarily indicate the current ringer volume setting.
- To adjust the handset volume, lift the handset and press the volume button  while the handset is off hook. The handset will remain at this volume until it is adjusted again.
- To adjust the speaker volume, press the volume button  while the speaker is activated (activate the speaker by pressing ; ensure handsfree speakerphone audio mode is set). The speaker will remain at this volume until it is adjusted again.

### Status Lights (LEDs)

The speaker LED, beside the  key, and the Message Waiting Indicator (MWI) LED, on the top right of your phone, provide visual indications of your phone's status.

#### *Speaker LED*

Speaker LED Status	Description
ON solid	Indicates a call is on Speaker (speakerphone)
Rapid Flash	Indicates the call is muted. Press  to take the call off mute.

#### *Message Waiting Indicator (MWI)*

MWI LED Status	Description
Slow Flash	Indicates you have a message(s).
Rapid Flash	Indicates you have an incoming call.
Even Flash	Indicates one or more calls are on hold.

### Call Timer

- When you make or answer a call, the Timer shows the elapsed time of the call.

## Programmable keys

There are 8 hard keys on the 6730i IP Phone phone, located at the top of the front panel display. Keys 5 and 6 (SAVE and DELETE keys) can be made programmable by the System Administrator. Keys 1, 2, 3, 4, 7, and 8 are fully programmable keys.

The following are the default functions for the programmable keys on the 6730i IP Phone IP phone.

Key	Default Function	Description
1	None	
2	None	
3	None	
4	None	
5	SAVE (preconfigured)	Allows you to save numbers and/or names to the Directory. Using this key, you enter the number, name, and line (or speeddial key) to record in the Directory List. <b>Note:</b> The SAVE key must be made configurable by the System Administrator before it can be changed.
6	DELETE (preconfigured)	Allows you to delete entries from the Directory List and Callers List. (Must enter the Directory or Callers list and select an entry, then press twice to delete entry). <b>Note:</b> The DELETE key must be made configurable by the System Administrator before it can be changed.
7	DIRECTORY (preconfigured)	Displays up to 200 names and phone numbers (stored in alphabetical order).
8	SERVICES (preconfigured)	Accesses enhanced features and services through the Services menu.

These keys can also be set up to quickly access features such as Call return (\*69) or Voicemail.

**Note:** Quick access features like Call return and Voicemail must first be configured on your PBX in order to work on your phone. See your system administrator for more information.

You must use the Aastra Web UI to configure the programmable keys.

For more information about programming keys with other functions on the 6730i IP Phone IP phone, see the *Aastra Model 6730i IP Phone User Guide*.

## Creating a Speeddial Key

The normal function of the speeddial option allows you to dial a number quickly by pressing a configured speeddial programmable key or keypad key. You can program the keys on the 6730i IP Phone to speeddial outside numbers, dial directly to another person's line or extension, or set up to quickly access features such as Caller ID (\*69), Voicemail.

**Note:** You can use a speeddial key while on an active call by placing the active call on hold first, and then pressing the speeddial key.

### ***Speeddial Prefix***

The speeddial feature also allows you to specify a preset string of numbers followed by a "+" that the phone dials automatically after pressing the speeddial key. You can use this feature for numbers that contain long prefixes.

For example, if you had the following speeddial configuration in the Aastra Web UI:

Key 1

Type=speeddial

Label=Europe Office

Value=1234567+

Line=2

then, after you press key 1 on the phone, the prefix number displays on the phone screen. The phone proceeds to dial the prefix number automatically and pauses for you to enter the remaining phone number using the keypad on the phone.

You can save up to 7 speeddial numbers on the 6730i IP Phone.

You can create speeddial keys using any of the following methods:

- Using the Aastra Web UI at the paths:
  - *Operation->Softkeys and XML*
  - *Operation->Programmable Keys*
  - *Operation->Speeddial Keys*
- Using the IP Phone UI at the path, *Options->Preferences->Speeddial Edit*
- By pressing and holding a programmable or keypad key.

### ***Reference***

For more information about creating speeddial keys using the Aastra Web UI, see the *Aastra 6730i User Guide*.

### ***Press-and-Hold Speeddial Key***

Pressing and holding down a programmable key or keypad key on the phone initiates a speeddial feature.

**Note:** When creating a speeddial key on a programmable key on the IP Phone UI, you must select a programmable key that has no preassigned function (key must be set to **None**). Pressing and holding a programmable key or keypad key that currently has a speeddial setting, allows you to edit that speeddial setting.

1. Press a programmable key or a number key on the keypad for 3 seconds. A screen displays with the prompt, "*Enter number*".
2. Enter a phone number or extension to assign to that speeddial key. The following example illustrates the screen display:

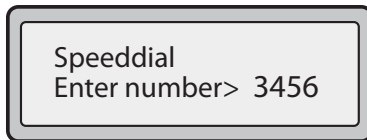

After entering the number, the prompt, "*Use Save to end*" displays on the screen.

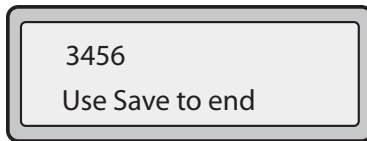

3. Press Save (key 5) to save the number as a speeddial key. By default, the phone automatically assigns the speeddial key to line 1 if available. To select a different line, press the **Change** key and select a different line, or use the phone's keypad to select a number (1-9), or use the  $\Delta$  and  $\nabla$  to make your selection.

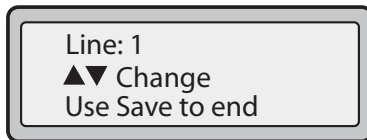

4. Press Save (key 5) to save the speeddial key to the line specified.

**Note:** Press and hold a speeddial key to edit that speeddial key. If you try to edit a digit key set to "**Empty**" or "**None**", the phone proceeds to enter the "**Add a Speeddial Key**" process. For more information about editing a speeddial key, see the *Aastra 6730i User Guide*.

## Speedial Key Edit

On the 6730i IP Phone, you can edit a speedial key using the IP Phone UI at

*Options->Preferences->Speed Dial Edit.*

The following illustration shows the path in the 6730i IP Phone IP Phone UI for editing a speedial key.

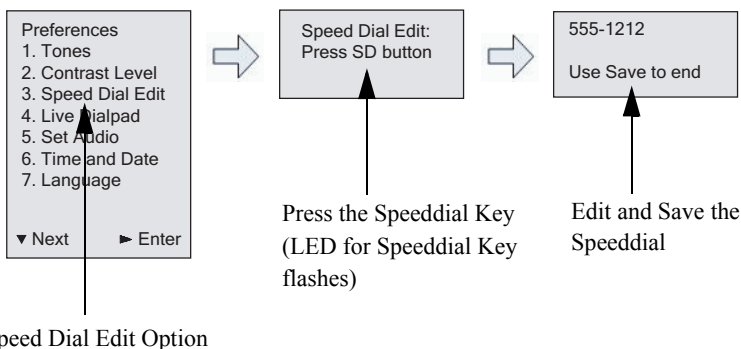

## Editing or Creating a Speedial Key Using the IP Phone UI

Use the following procedure to edit a speedial key from the IP Phone UI.

**Note:** \*A speedial key must be already configured on the phone to edit the key.

1. Press  on the phone to enter the Options List.
2. Select **Preferences**.
3. Select **Speed Dial Edit**.

All current speedial key LEDs flash RED (for programmable keys and expansion module keys). All other function key LEDs turn off, during this process. After you press a speedial key for editing, the phone restores all key LEDs to their previous state.

4. Press a speedial key you want to edit.  
The speedial edit screen displays.

**Note:** If a number on the keypad is setup as a speedial key, pressing the applicable number in the speedial editing process also displays the speedial edit screen. The edit screen allows you to change the Speedial Number and Line setting.

**Note:** If you press a key that is NOT setup as a speedial key, the phone displays an "Invalid Key" message. However, if you press-and-hold an empty digit key, programmable key set to "NONE", or expansion module key, it initiates the "Add a Speedial Key" process allowing you to setup a new speedial key. For more information, see the *Aastra 6730i User Guide*.

5. Edit the speedial information as applicable and press **Save (key 5)**.

**Note:** 1.Cancel out of the speedial editing process at any time without saving, by pressing the  key.

2.Use the (up arrow) key to cancel when in Extension editing or the 3 (left arrow) key to cancel if in Line editing. Pressing either of these keys displays the idle screen.

3.Remove the Speedial Key by erasing the speedial number digits (leaving the

speeddial value blank) and then pressing Save (key5) or the (right arrow) key. Use the left arrow key to delete the digits.

### **Reference**

For more information about creating and editing speeddial keys, see the *Aastra 6730i User Guide*.

### **Line/Call Appearance Keys**

The 6731i has 2 hard/line call appearance keys each with a corresponding status light. Additional line call appearances may also be set up on your phone as programmable keys which also have status lights. The 6731i supports up to 6 line keys in total (2 hard, 4 programmable).

These line call appearance buttons and lights represent physical lines or calls for your extension. By pressing a line call appearance button, you connect to the line or a call it represents. The line call appearance light indicates the status of that line or call.

When the phone is taken off-hook, the phone will automatically select a line for you.

<b>Line Call Appearance LED Status</b>	<b>Description</b>
<b>OFF</b>	Indicates idle line or no call activity
<b>Rapid Flash</b>	Indicates ringing on the line.
<b>Slow Flash</b>	Indicates a call is on hold.

For more information about the Line Call Appearance keys, see the *Aastra Model 6730i IP Phone User Guide*.



## Troubleshooting Solutions

### ***Why is the light not coming on with a new Voice Mail Message?***

Your phone system or service provider must provide "Visual" Message Waiting service for this function to work. Check with your system administrator for more information.

### ***Why is my handset not working?***

Check to ensure that the handset cord is fully connected to both the phone and handset. See the section "**Connecting a Handset**" on [page 9](#) for information.

### ***Why is my display blank?***

Ensure that power is being provided to your phone.

### ***Why can I only see one option when the installation guide or user guide says there are more?***

The telephone screen will only show one option at a time. To see more, press the down arrow button .

### ***Why does the telephone wobble?***

Make sure the cords are routed properly through the back of the phone, as indicated in the section, "**Connecting a Handset**" on [page 9](#). Check that the leg stands have been properly snapped into place. Since the legs can be oriented in two different ways and in two different positions to offer four different phone viewing angles, check that both legs are oriented in the same direction and in the same position on either side of the phone.

### ***What is a programmable key?***

There are 8 top hard keys (programmable up to 8 functions), located at the top of the front panel. These are keys that you can set to perform specific functions and access enhanced services provided by third parties (for example, XML applications). See the section "**Programmable keys**" on [page 22](#) or refer to your *Aastra Model 6730i IP Phone User Guide* for more information.



## Limited Warranty

Aastra Telecom warrants this product against defects and malfunctions during a one (1) year period from the date of original purchase. If there is a defect or malfunction, Aastra Telecom shall, at its option, and as the exclusive remedy, either repair or replace the telephone set at no charge, if returned within the warranty period.

If replacement parts are used in making repairs, these parts may be refurbished, or may contain refurbished materials. If it is necessary to replace the telephone set, it may be replaced with a refurbished telephone of the same design and color. If it should become necessary to repair or replace a defective or malfunctioning telephone set under this warranty, the provisions of this warranty shall apply to the repaired or replaced telephone set until the expiration of ninety (90) days from the date of pick up, or the date of shipment to you, of the repaired or replacement set, or until the end of the original warranty period, whichever is later. Proof of the original purchase date is to be provided with all telephone sets returned for warranty repairs.

### Exclusions

Aastra Telecom does not warrant its telephone sets to be compatible with the equipment of any particular telephone company. This warranty does not extend to damage to products resulting from improper installation or operation, alteration, accident, neglect, abuse, misuse, fire or natural causes such as storms or floods, after the telephone is in your possession.

Aastra Telecom shall not be liable for any incidental or consequential damages, including, but not limited to, loss, damage or expense directly or indirectly arising from the customer's use of or inability to use this telephone, either separately or in combination with other equipment. This paragraph, however, shall not apply to consequential damages for injury to the person in the case of telephones used or bought for use primarily for personal, family or household purposes.

This warranty sets forth the entire liability and obligations of Aastra Telecom with respect to breach of warranty, and the warranties set forth or limited herein are the sole warranties and are in lieu of all other warranties, expressed or implied, including warranties or fitness for particular purpose and merchantability.

### Warranty Repair Services

Should the set fail during the warranty period;

**In North America**, please call 1-800-574-1611 for further information.

**Outside North America**, contact your sales representative for return instructions.

You will be responsible for shipping charges, if any. When you return this telephone for warranty service, you must present proof of purchase.

### After Warranty Service

Aastra Telecom offers ongoing repair and support for this product. This service provides repair or replacement of your Aastra Telecom product, at Aastra Telecom's option, for a fixed charge. You are responsible for all shipping charges. For further information and shipping instructions;

**In North America**, contact our service information number: 1-800-574-1611.

**Outside North America**, contact your sales representative.

**Note:** Repairs to this product may be made only by the manufacturer and its authorized agents, or by others who are legally authorized. This restriction applies during and after the warranty period. Unauthorized repair will void the warranty.



# Index

## A

administrator menu 20

## C

call forward 17

call timer 21

callers list key 5

conference key 6

connecting

handset 9

contrast level, setting 18

customizing your phone 14

## D

date

setting date 19

setting date format 19

daylight savings 19

delete key 7, 22

desk installation 9

directory key 7, 22

## F

features 1

## G

goodbye key 5

## H

handset volume 21

handset, connecting 9

hold key 5

## I

indicator light 21

installation

desk 9

stand 9

wall 10

installation and setup 8

introduction 1

IP address, viewing 20

## K

key card 13

keys

callers list 5

conference 6

delete 7, 22

description 5

directory 7, 22

goodbye 5

hold 5

line 6

mute 21

navigation 5

options 5

panel 4

programmable 7, 22

redial 5

save 7, 22

services 7, 22

speaker 5

transfer 6

volume control 5

## L

label card 13

language 19

lights or LEDs

MWI 21

speaker 21

status 21

line keys 6

line settings 26

locking phone 20

## M

MAC address, viewing 20

message waiting indicator. *See* MWI

mute key 21

MWI 21

## N

navigation keys 5

## O

options key 5

## P

parts 3

password, user 20

phone

features 1

lock 20

parts 3

requirements 1

phone status 20

power adapter 8

programmable keys

about 7

# Index

- default functions 22
- label card 13

## R

- redial key 5
- requirements 1
- restart phone 20
- ringer volume 21

## S

- save key 7, 22
- services key 7, 22
- speaker key 5
- speaker volume 21
- speeddial
  - prefix for 23
- speeddial key, creating from phone key-pad 23
- speeddial keys, editing 25
- stand installation 9

## T

- time
  - setting format 19
  - setting time 19
  - setting time server 19
  - setting time zone 19
- time and date, setting 19
- tone set, setting 18
- transfer key 6

## U

- user password 20

## V

- volume
  - adjusting 21
  - control keys 5
  - handset 21
  - ringer 21
  - speaker 21

## W

- wall installation 10
- warranty, limited 29
- Web UI, using 15



If you've read this owner's manual and consulted the Troubleshooting section and still have problems, please visit our Web site at [www.aastra.com](http://www.aastra.com), or call 1-800-574-1611 for technical assistance.

© Aastra Telecom Inc. 2008 41-001277-00 Rev 00