

Software License Agreement

Aastra Telecom Inc., hereinafter known as "Seller", grants to Customer a personal, worldwide, non-transferable, non-sublicenseable and non-exclusive, restricted use license to use Software in object form solely with the Equipment for which the Software was intended. This Product may integrate programs, licensed to Aastra by third party Suppliers, for distribution under the terms of this agreement. These programs are confidential and proprietary, and are protected as such by copyright law as unpublished works and by international treaties to the fullest extent under the applicable law of the jurisdiction of the Customer. In addition, these confidential and proprietary programs are works conforming to the requirements of Section 401 of title 17 of the United States Code. Customer shall not disclose to any third party such confidential and proprietary programs and information and shall not export licensed Software to any country except in accordance with United States Export laws and restrictions.

Customer agrees to not reverse engineer, decompile, disassemble or display Software furnished in object code form. Customer shall not modify, copy, reproduce, distribute, transcribe, translate or reduce to electronic medium or machine readable form or language, derive source code without the express written consent of the Seller and its Suppliers, or disseminate or otherwise disclose the Software to third parties. All Software furnished hereunder (whether or not part of firmware), including all copies thereof, are and shall remain the property of Seller and its Suppliers and are subject to the terms and conditions of this agreement. All rights reserved.

Customer's use of this software shall be deemed to reflect Customer's agreement to abide by the terms and conditions contained herein. Removal or modification of trademarks, copyright notices, logos, etc., or the use of Software on any Equipment other than that for which it is intended, or any other material breach of this Agreement, shall automatically terminate this license. If this Agreement is terminated for breach, Customer shall immediately discontinue use and destroy or return to Seller all licensed software and other confidential or proprietary information of Seller. In no event shall Seller or its suppliers or licensors be liable for any damages whatsoever (including without limitation, damages for loss of business profits, business interruption, loss of business information, other pecuniary loss, or consequential damages) arising out of the use of or inability to use the software, even if Seller has been advised of the possibility of such damages.

Table of Contents

Software License Agreement	iii
Introduction	1
Phone Features	1
Requirements	2
About This Guide	2
Phone Parts	3
Optional Accessories for 6739i (Not Included)	3
Key Panel	4
Key Descriptions	5
Installation and Setup	7
Direct or Shared Network Connection	7
Connecting to the Network and to Power	9
Connecting a Handset, Headset, or DHSG Headset	11
Desk or Wall Installation.....	13
Customizing your phone	16
Other Phone Features	16
Adjusting the Volume.....	17
Status Lights (LEDs).....	17
Call Timer.....	17
Line/Call Appearance Keys.....	18
Using a Headset with your Telephone	18
Troubleshooting Solutions	19
Limited Warranty	21

Introduction

Congratulations on your purchase of the Model 6739i IP telephone! The 6739i communicates over an IP network allowing you to place and receive calls in the same manner as a regular business telephone. The 6739i is capable of supporting the SIP IP protocol.

Phone Features

- 5.7" VGA Thin Film Transistor (TFT) technology graphical LCD with touch screen and backlight capabilities
- Bluetooth headset support
- 3 call appearance line keys with LEDs
- USB jack
- Full-duplex speakerphone for handsfree calls
- Headset support jack
- DHSG headset jack
- Legacy Expansion Module support
- Next generation Expansion Module support
- Built-in-2-port, 10/100/1000 Ethernet switch - lets you share a connection with your computer.
- Inline power support (based on 802.3af Power-over-Ethernet (PoE) standard) which eliminates power adapters
- AC power adapter (sold separately)

Requirements

The 6739i IP Phone requires the following environment:

- SIP-based IP PBX system or network installed and running with a SIP account created for the 6739i phone.
- Access to a Trivial File Transfer Protocol (TFTP) server, File Transfer Protocol (FTP) server, Hypertext Transfer Protocol (HTTP) server, or Hyper Text Transfer Protocol over Secure Sockets Layer (SSL) (HTTPS) server.
- Ethernet/Fast Ethernet LAN (10/100 BaseT), Gigabit Ethernet LAN (1000 BaseT) recommended
- Category 5/5e straight through cabling
- Power source

For Ethernet networks that supply in-line power to the phone (IEEE 802.3af):

- For power, use the Ethernet cable (supplied) to connect from the phone directly to the network for power. (No 48v AC power adapter required.)

For Ethernet networks that DO NOT supply power to the phone:

- (optional) For power, use the 48V AC Power Adapter (optional accessory) to connect from the DC power port on the phone to a power source.
- or
- (optional) - For power, use a Power over Ethernet (PoE) power injector or a PoE switch. A PoE power injector is available as an optional accessory from Aastra Telecom. Contact your Administrator for more information.

About This Guide

This manual describes how to physically set up your new 6739i. Not all features listed are available by default and some may depend on your phone system or service provider. Contact your system administrator if you have any questions on what features and services are available to you on your system. This guide complements the *Aastra SIP IP Phone Administrator Guide* and the *Aastra Model 6739i User Guide*.

Aastra SIP IP Phone Administrator Guide – is designed for network administrators, system administrators, developers and partners who need information on installing this product on an IP network.

Aastra Model 6739i IP Phone User Guide – explains the most commonly used IP telephone features for an end user.

These guides along with release notes, system updates, etc. can be downloaded from our Web site at www.aastratelecom.com.

Phone Parts

When you unpack your phone, you should ensure that you have all of the following items. If any part is missing, contact the supplier of your phone.

6739i SIP IP Phone

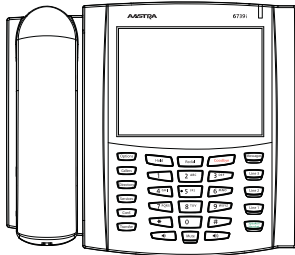

Telephone



Handset



Handset Cord

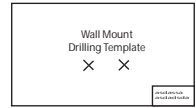

Wall Mount
Drilling Template

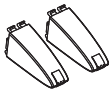

Telephone
Base Desk
Legs



Ethernet Cable

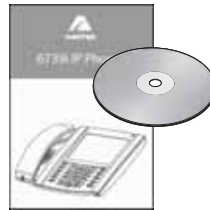

6739i Installation
Guide on CD



Screws and
Anchors for
Wall Mounting

Optional Accessories for 6739i (Not Included)

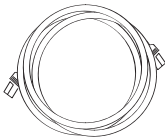

Additional Ethernet Cable
(category 5/5e straight
through cable)



Power
Adapter

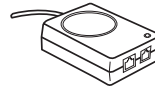

PoE (Power over Ethernet)
Inline Power Injector

A PoE (Power over Ethernet) inline power injector supplies 48v power to the 6739i through the Ethernet Cable on pins 4 & 5 and 7 & 8.







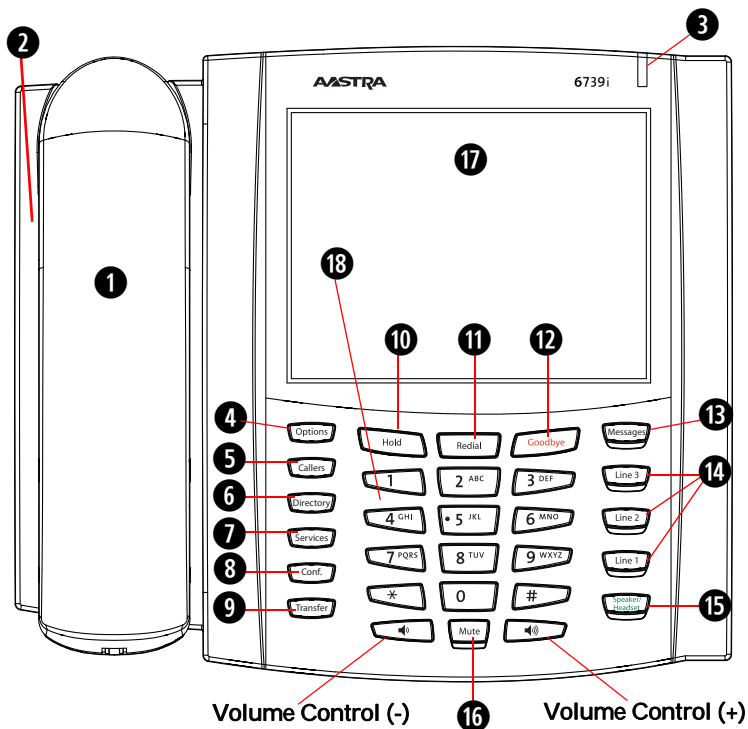





Warning: Do not use this PoE inline power injector to power other devices.







Key Panel



1	Handset	10	Hold key
2	Speakerphone	11	Redial
3	Message Waiting Lamp	12	Goodbye Key
4	Options Key	13	Messages Key
5	Callers List Key	14	Three (3) Call Appearance Lines
6	Directory Key	15	Speakerphone/Headset Toggle Key
7	Services Key	16	Mute Key
8	Conference Key	17	Color LCD Touch Screen
9	Transfer key	18	Keypad

Key Descriptions

Keys	Key Description
	Options Key - Accesses options to customize your phone. Your System Administrator may have already customized some of your settings. Check with your System Administrator before changing the administrator-only options.
	Callers List Key - Accesses a list of calls received by the phone.
	Directory Key - Accesses a directory of names and phone numbers (stored in alphabetical order).
	Services Key - Accesses enhanced features and services set up by your System Administrator.
	Conference Key - Begins a conference call with the active call.
	Transfer Key - Transfers the active call to another number.
	Hold Key - Places an active call on hold. To retrieve a held call, press the call appearance button beside the light that is flashing.
	Redial Key - Redials previously dialed numbers. Pressing the Redial key twice simultaneously redials the last dialed number.
	Goodbye Key - Ends an active call. The Goodbye key also exits an open list, such as the Options List, without saving changes.
	Messages Key - Accesses your phone's voice mailbox to retrieve and listen to stored messages.

Keys	Key Description
  	<p>Line/Call Appearance Keys - Connect you to a line or call. The Aastra 6739i IP Phone IP phone supports 3 line keys.</p>
	<p>Speakerphone/Headset Key - Activates Handsfree for making and receiving calls without lifting the handset. When the audio mode option is set, this key is used to switch between a headset and the handsfree speakerphone. See "Customizing your phone" on page 16 for more information.</p>
	<p>Volume control key - Adjusts the volume for the handset, headset, ringer, and handsfree speaker. See "Adjusting the Volume" on page 17 for more information.</p>
	<p>Mute key - Mutes the microphone so that your caller cannot hear you (the light indicator flashes when the microphone is on mute).</p>

Installation and Setup

The 6739i can be setup to share a network connection with another network device. Power can be provided by an AC adapter (optional accessory), an 802.3af compliant network power source, or with a PoE inline power injector (optional accessory). It can also be installed on a desk or mounted on the wall. If your Network Administrator has already setup your phone, please refer to the *6739i User Guide* for call handling information or contact your Network Administrator.

Note: You can download the *Aastra Model 6739i IP Phone User Guide* from the Aastra Web site at www.aastratelecom.com

Direct or Shared Network Connection

The phone can be set up as a direct network connection to the Ethernet wall jack or as a shared network connection as a pass-through if connecting a computer or another network device to the phone.

Direct Network Connection

Located at the top of the phone are two fully switched 10/100/1000 Mbps Ethernet cable ports. The port marked with **LAN** is used to connect the phone to the network, as well as provide power to your phone (if required). See the section "[Connecting to the Network and to Power](#)" on [page 9](#) for more information.

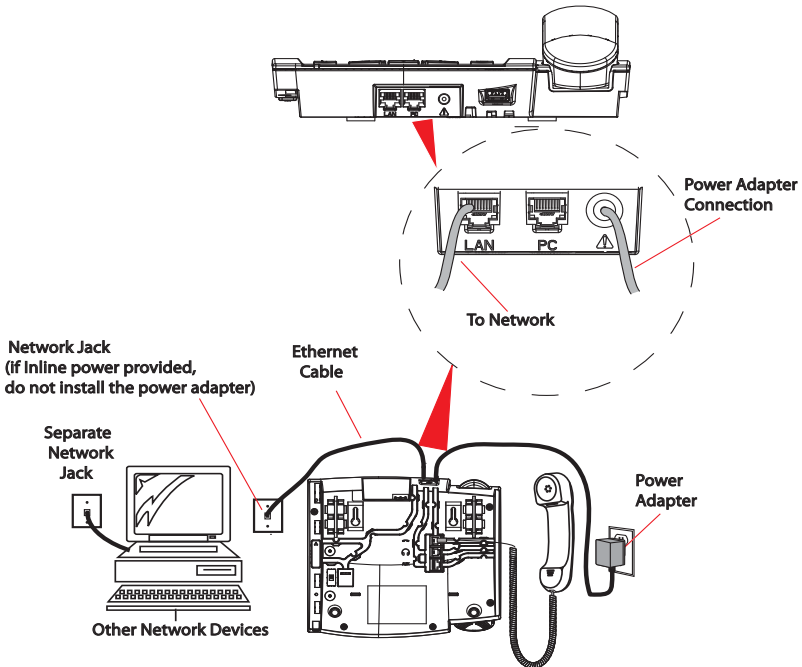

Shared Network Connection

To connect a network device (such as a computer) to the phone, connect an Ethernet cable into the network port on the top of the phone marked **PC**. Plug the other end of the Ethernet cable into the network port on the network device with which you are sharing the network connection.

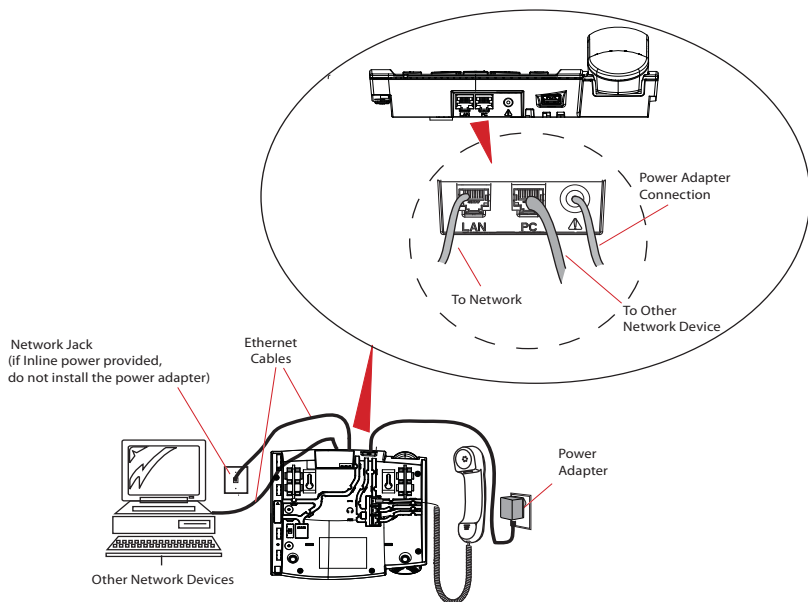

Note: The **PC** jack on the 6739i does not supply in-line power onto other network devices. All Ethernet cables used must be category 5/5e straight-through cables, such as the cable provided with your phone

Connecting to the Network and to Power

Inline Power Provided

If your network provides 802.3af compliant in-line power, the phone is powered through the network.

1. On the top of your phone, connect the Ethernet cable (provided with your phone) into the network port marked with **LAN**.
2. Plug the other end of the Ethernet cable directly into the network jack on the wall.

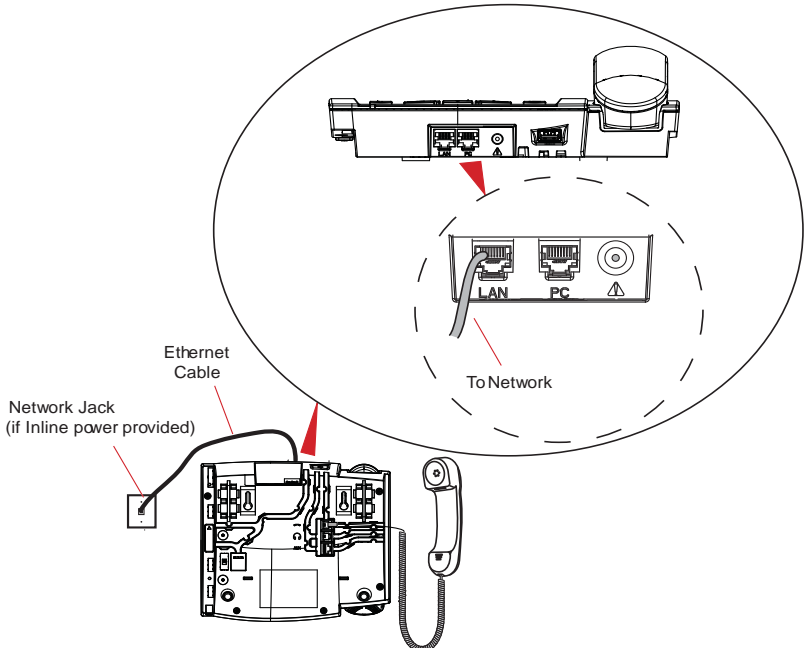

Inline Power Not Provided

If your network does not provide 802.3af compliant in-line power, you need to install the supplied AC adapter or the PoE inline power injector (optional accessory).

1. On the top of your phone, connect the Ethernet cable (provided with your phone) into the network port marked with **LAN**.
2. On the PoE power injector, plug the other end of the Ethernet cable into the network jack marked as indicated in the following illustration.
3. On the PoE power injector, connect an additional Ethernet cable into the network port as indicated in the following illustration.
4. Plug the other end of the Ethernet cable into the network jack on the wall.
5. Plug the PoE power injector into a power outlet.

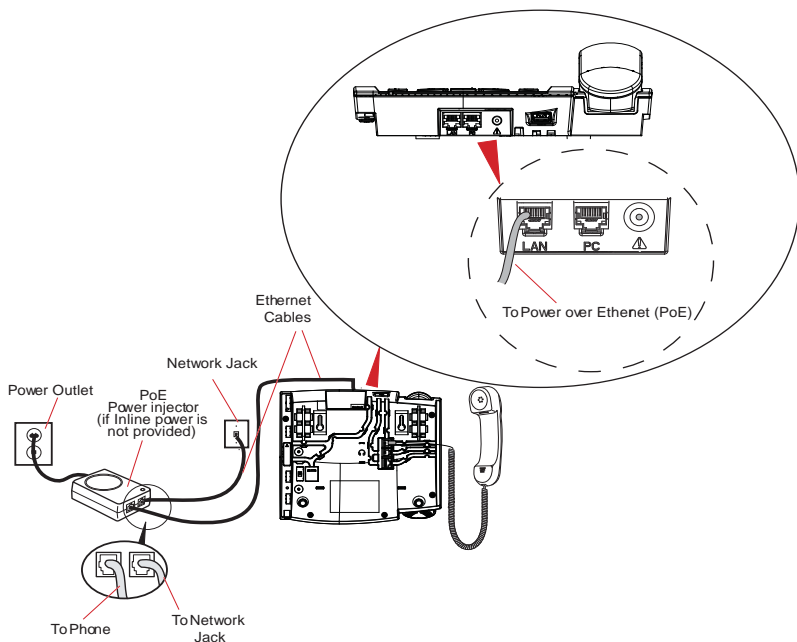

Note: You should connect the power supply to a surge protector or power bar. All Ethernet cables used must be category 5/5e straight-through cables, such as the cable provided with your phone.

Connecting a Handset, Headset, or DHSG Headset

Handset

To connect the handset to the phone:

1. On the back of the phone base, locate the handset port marked  . Insert one end of handset cord into the port until it clicks into place.
2. Route the handset cord through the channel as shown in the illustration on [page 12](#).
3. Attach the handset to the other end of the handset cord.

Headset (Optional)

To connect a headset to the phone:

1. On the back of the phone base, locate the headset port marked  . Insert the headset cord into the port until it clicks into place.
2. Route the headset cord through the channel as shown in the above illustration on [page 12](#).

DHSG Headset (Optional)

You can attach an optional DHSG headset to the 6739i IP Phone if required.

To connect a DHSG headset to the phone:

1. On the back of the phone base, locate the DHSG port marked **AUX**.
2. Attach your 3rd party DHSG headset cable to Aastra's DHSG jack.

Note: DHSG headsets may require further configuration before use. Refer to your headset documentation or contact your headset vendor for more information.

Attaching Cords and Cables

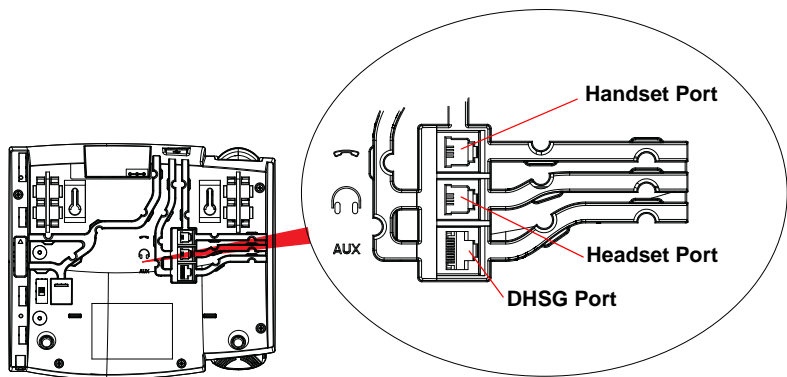

Ports on Back of Phone Base

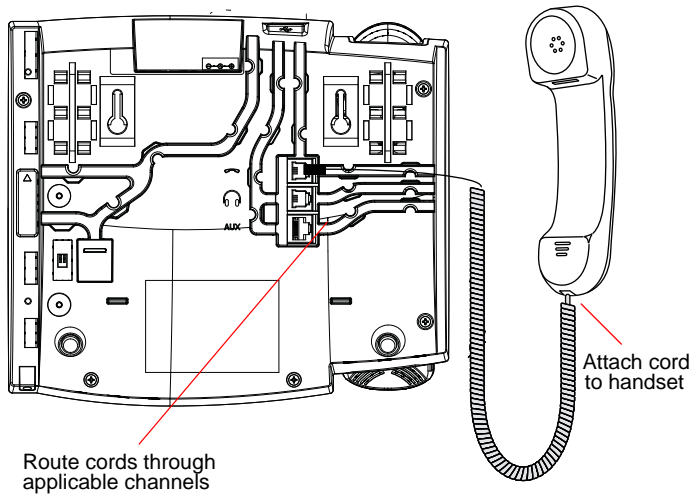

Attaching Cords to the Phone Base

Desk or Wall Installation

Install on the Desk

The desk installation for the 6739i IP phone consists of two legs that attach to the back of the phone near the top corners. A total of four different viewing angles allows users to personalize their phone viewing preference.

1. Attach each leg by inserting the tabs on the leg into the slots on the bottom of the phone. There are three pair of leg slots on each corner of the phone; each leg uses two pairs (1&2, or 2&3) giving two leg positions designating different viewing angles. Furthermore, the legs can be reversed which offer two additional viewing angles.
2. For a higher viewing angle, use the second and third slots from the top.
3. For a lower viewing angle, use the first and second slots from the top.
4. Push the stand towards the phone until it snaps into place.

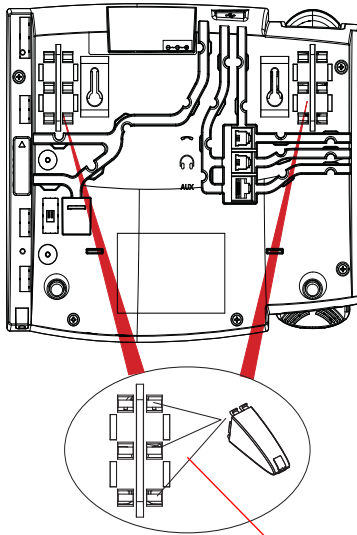

Three leg slot locations for customizing the height of the desk phone.

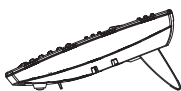

20.7 deg.
Incline Angle

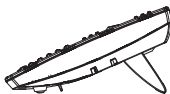

23.3 deg.
Incline Angle



26.6 deg.
Incline Angle

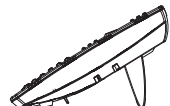

30.9 deg.
Incline Angle

Total 4 Viewing Angles

Install on the Wall

The 6739i IP phone has two pre-drilled wall mounting holes on the back of the phone.

1. Using the provided wall mount drilling template, locate and mark the position for the mounting screws on the wall. Depending on the wall type, you may need to use wall anchors. Both the screws and wall anchors are included with your phone.
2. Place the wall mount holes on the phone over the screw heads on the wall and pull down to lock the phone in.

Note: You may wish to purchase a short Ethernet cable from a local supplier for a wall installation. Also, if 802.3af compliant in-line power is not provided on your network, and you are installing the 6739i on a wall using a PoE in-line power injector, you may also wish to use an equivalent flat Ethernet cable rather than the one provided.

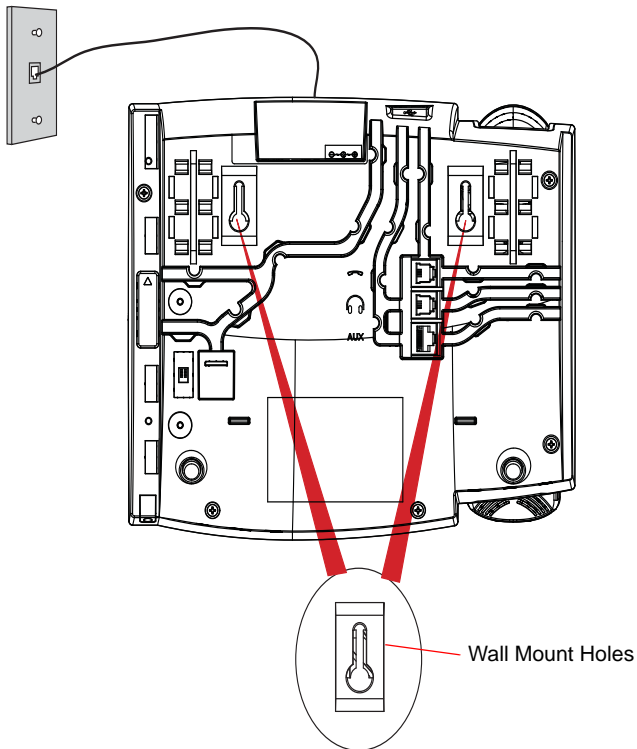

3. In the handset cradle, there is a small clip that sits flush with the cradle surface. Using a small flathead screwdriver, pull the clip up and remove it from the phone.
4. With the arms on the clip facing you and the flat side of the clip towards the phone, turn the clip 180 degrees and reinsert it back into the clip cavity in the phone's cradle.

5. Push the clip in until it snaps into the slot flush with the surface and only the legs on the clip are sticking up.

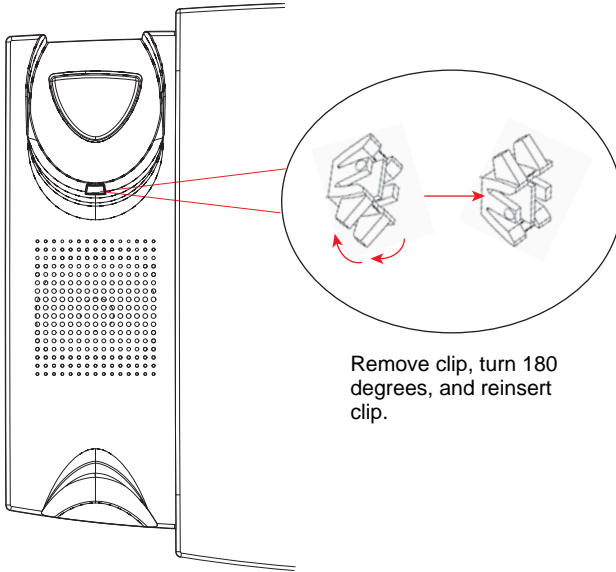

6. Place the handset into the phone's cradle, inserting the legs on the clip into the square hole on the handset. This allows the handset to rest in the cradle in a vertical position without slipping off when the phone is installed on the wall.

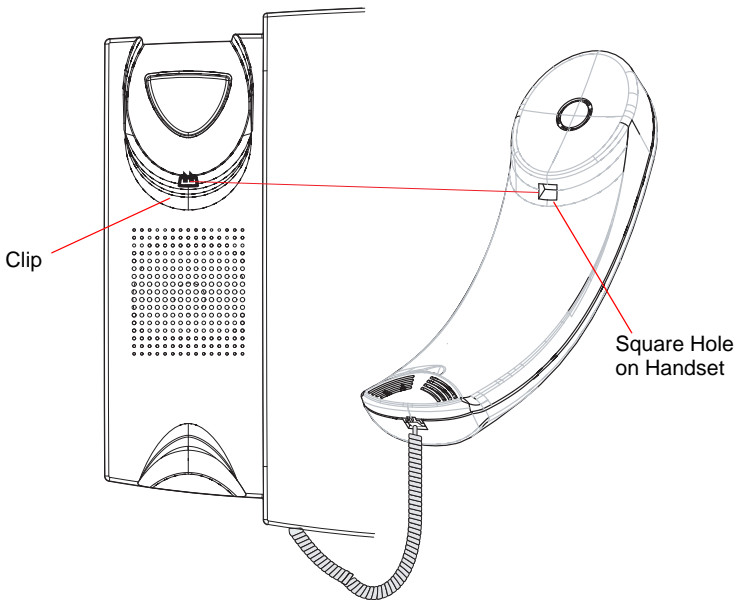

Customizing your phone

Your 6739i is a feature-rich IP Phone that allows you to customize and configure it with the touch of your finger and/or the press of a button.





You can access configuration options by pressing the  button on the phone. You can also access options using the Aastra Web User Interface (UI) to the phone.

For more information about using these features and options on your phone, see your *Aastra Model 6739i IP Phone User Guide* available from the Aastra Telecom Web site at www.aastratelecom.com.

Other Phone Features

Set Audio

The 6739i allows you to use a handset, a headset, or handsfree to handle incoming and outgoing calls. The audio mode option provides different combinations of these three methods to provide maximum flexibility in handling calls. There are four audio mode options to choose from:











Audio Mode Option	Description
Speaker	This is the default setting. Calls can be made or received using the handset or handsfree speakerphone. In handset audio mode, pressing the  button on the phone switches to handsfree speakerphone. In Speaker audio mode, lift the handset to switch to the handset.
Headset	Choose this setting if you want to make or receive all calls using a handset or headset. Calls can be switched from the handset to headset by pressing the  button on the phone. To switch from the headset to the handset, lift the handset.
Speaker/Headset	Incoming calls are sent to the handsfree speakerphone first when the  button is pressed. By pressing the button again, you can switch back and forth between the handsfree speakerphone and the headset. At anytime, lifting the handset switches back to the handset from either the handsfree speakerphone or the headset.
Headset/Speaker	Incoming calls are sent to the headset first when the  button is pressed. By pressing the button again, you can switch back and forth between the headset and the handsfree speakerphone. At anytime, lifting the handset switches back to the handset from either the headset or the handsfree speakerphone.

Headset Mic Volume

To adjust the headset microphone volume, press **Advanced** after selecting the audio option, and then select the **Low**, **Medium**, or **High** volume level.

Adjusting the Volume

Pressing the volume button   adjusts the receiver, headset, speaker, and ringer volume.

- To adjust the ringer volume, leave the handset in the cradle and press the volume button   while there is no active call. There are 10 settings for the ringer including Off — the display will temporarily indicate the current ringer volume setting.
- To adjust the handset volume, lift the handset and press the volume button   while the handset is off hook. The handset will remain at this volume until it is adjusted again.
- To adjust the headset volume, press the volume button   while the headset is activated (activate the headset by pressing ; ensure headset audio mode is set). The headset will remain at this volume until it is adjusted again.
- To adjust the speaker volume, press the volume button   while the speaker is activated (activate the speaker by pressing ; ensure handsfree speakerphone audio mode is set). The speaker will remain at this volume until it is adjusted again.

Status Lights (LEDs)

The speaker LED, beside the  key, and the Message Waiting Indicator (MWI) LED, on the top right of your phone, provide visual indications of your phone's status.

Speaker LED

Speaker LED Status	Description
ON solid	Indicates a call is on Handsfree (speakerphone)
Slow Flash	Indicates you are using the headset.
Rapid Flash	Indicates the call is muted. Press  to take the call off mute.

Message Waiting Indicator (MWI)

MWI LED Status	Description
Slow Flash	Indicates you have a message(s).
Rapid Flash	Indicates you have an incoming call.
Even Flash	Indicates one or more calls are on hold.

Call Timer

- When you make or answer a call, the Timer shows the elapsed time of the call.

Line/Call Appearance Keys

The 6739i has 3 hard/line call appearance keys each with a corresponding status light. Additional line call appearances may also be set up on your phone as softkeys.

These line/call appearance buttons and lights represent physical lines or calls for your extension. By pressing a line call appearance button, you connect to the line or a call it represents. The line call appearance light indicates the status of that line or call.

When the phone is taken off-hook, the phone will automatically select a line for you.

Line Call Appearance LED Status	Description
OFF	Indicates idle line or no call activity
Rapid Flash	Indicates ringing on the line.
Slow Flash	Indicates a call is on hold.



For more information about the Line Call Appearance keys, see the *Aastra Model 6739i IP Phone User Guide*.

Using a Headset with your Telephone

The 6739i accepts standard and DHSG headsets through a modular port on the back of the phone. Contact your telephone equipment retailer or distributor to purchase a compatible headset. A non-amplified headset is required. Customers should read and observe all safety recommendations contained in headset operating guides when using any headset.

Note: For best headset performance, Aastra recommends non-amplified headset equipped with modular connector.

Making and Receiving Calls using a Headset

1. Ensure that you have selected a headset audio mode by accessing the Options menu. See the section "[Set Audio](#)" on [page 16](#) for detailed information.
2. Plug the headset into jack.
3. Press the  key to obtain dial tone or answer an incoming call. Depending on the audio mode selected from the Options menu, dial tone or an incoming call will be received on either the headset or the handsfree speakerphone.
4. Press the  key to end the call.

Troubleshooting Solutions



Why is the light not coming on with a new Voice Mail Message?

Your phone system or service provider must provide "Visual" Message Waiting service for this function to work. Check with your system administrator for more information.

Why is my handset not working?

Check to ensure that the handset cord is fully connected to both the phone and handset. See the section "[Connecting a Handset, Headset, or DHSG Headset](#)" on [page 11](#) for information.

Why is my speakerphone not working?

If you press  and the speaker light flashes and you do not hear dial tone, the Set Audio option has been used to set up the phone for headset use; press  a second time. If the light goes out, the phone is set up to be used only with a headset or handset. If the light stays on steady and you hear dial tone, you can alternate between the speakerphone and the headset by pressing . See the section, "[Set Audio](#)" on [page 16](#) for instructions on how to change the Set Audio feature.

Why is my display blank?

Ensure that power is being provided to your phone. If your Network does not provide Inline power over Ethernet, you can obtain an additional accessory, the a PoE inline power injector, to provide power over Ethernet locally to your phone. See the section "[Connecting to the Network and to Power](#)" on [page 9](#) for details.

Can I turn the backlight for the screen on and off?

Yes. You can use the IP phone UI to turn ON and OFF the backlight for the screen.

1. Press the  key.
2. Select **Display>Backlight**.
3. Press the **Change** key to turn the backlight on and off.
4. Press **Save** to save the change.

Why does the telephone wobble?

Make sure the cords are routed properly through the back of the phone, as indicated in the section, "[Connecting a Handset, Headset, or DHSG Headset](#)" on [page 11](#). Check that the leg stands have been properly snapped into place. Since the legs can be oriented in two different ways and in two different positions to offer four different phone viewing angles, check that both legs are oriented in the same direction and in the same position on either side of the phone.

Limited Warranty

Aastra Telecom warrants this product against defects and malfunctions during a one (1) year period from the date of original purchase. If there is a defect or malfunction, Aastra Telecom shall, at its option, and as the exclusive remedy, either repair or replace the telephone set at no charge, if returned within the warranty period.

If replacement parts are used in making repairs, these parts may be refurbished, or may contain refurbished materials. If it is necessary to replace the telephone set, it may be replaced with a refurbished telephone of the same design and color. If it should become necessary to repair or replace a defective or malfunctioning telephone set under this warranty, the provisions of this warranty shall apply to the repaired or replaced telephone set until the expiration of ninety (90) days from the date of pick up, or the date of shipment to you, of the repaired or replacement set, or until the end of the original warranty period, whichever is later. Proof of the original purchase date is to be provided with all telephone sets returned for warranty repairs.

Exclusions

Aastra Telecom does not warrant its telephone sets to be compatible with the equipment of any particular telephone company. This warranty does not extend to damage to products resulting from improper installation or operation, alteration, accident, neglect, abuse, misuse, fire or natural causes such as storms or floods, after the telephone is in your possession.

Aastra Telecom shall not be liable for any incidental or consequential damages, including, but not limited to, loss, damage or expense directly or indirectly arising from the customers use of or inability to use this telephone, either separately or in combination with other equipment. This paragraph, however, shall not apply to consequential damages for injury to the person in the case of telephones used or bought for use primarily for personal, family or household purposes.

This warranty sets forth the entire liability and obligations of Aastra Telecom with respect to breach of warranty, and the warranties set forth or limited herein are the sole warranties and are in lieu of all other warranties, expressed or implied, including warranties or fitness for particular purpose and merchantability.

Warranty Repair Services

Should the set fail during the warranty period;

In North America, please call 1-800-574-1611 for further information.

Outside North America, contact your sales representative for return instructions.

You will be responsible for shipping charges, if any. When you return this telephone for warranty service, you must present proof of purchase.

After Warranty Service

Aastra Telecom offers ongoing repair and support for this product. This service provides repair or replacement of your Aastra Telecom product, at Aastra Telecom's option, for a fixed charge. You are responsible for all shipping charges. For further information and shipping instructions;

In North America, contact our service information number: 1-800-574-1611.

Outside North America, contact your sales representative.

Note: Repairs to this product may be made only by the manufacturer and its authorized agents, or by others who are legally authorized. This restriction applies during and after the warranty period. Unauthorized repair will void the warranty.

Index

Numerics

6739i line settings 18

A

audio, setting 16

C

call timer 17

callers list key 5

conference key 5

customizing your phone 16

D

desk installation 13

F

features, IP phone 1

H

handset, connecting 11

handset mode 16

handset, connecting 11

handset, making and receiving calls with 18

handset/speaker mode 16

I

indicator light 17

inline power

not provided 10

provided 9

introduction 1

K

key descriptions 5

key panel 4

keys

callers list 5

conference 5

line 6

transfer 5

L

lights or LEDs

MWI 17

speaker 17

status 17

line keys 6

M

microphone volume, headset 16

MWI (message waiting indicator) 17

N

network

connecting to 9

connecting to direct or shared 7

O

other phone features 16

P

phone parts 3

power, connecting to 9

R

requirements, for IP phone 2

S

speaker mode 16

speaker/headset mode 16

T

transfer key 5

troubleshooting solutions 19

V

volume, adjusting 17

W

wall installation 14

warranty, limited 21

If you've read this owner's manual and consulted the Troubleshooting section and still have problems, please visit our Web site at www.aastra.com, or call 1-800-574-1611 for technical assistance.

© Aastra Telecom Inc. 2009 41-001310-00 Rev 01